

900 Wilshire

SIGN PROGRAM

900 Wilshire Blvd.

Santa Monica, CA

May 23, 2017



TABLE OF CONTENTS

TENANT PROCEDURES / STANDARDS / PROHIBITED SIGNS

1A

Tenant Signs

TENANT SIGN GENERAL REQUIREMENTS

2A

TENANT SIGN REQUIRED SPECIFICATIONS

2B

TENANT SIGN TYPICAL PLACEMENT

2C

TENANT SIGN TYPICAL SECTION

2D

TENANT SIGN REQUIRED FONTS & LIGHTING

2H

Building Address

BUILDING ADDRESS GENERAL REQUIREMENTS

3A

BUILDING ADDRESS REQUIRED SPECIFICATIONS

3B

BUILDING ADDRESS ELEVATION & PLACEMENT

3C

BUILDING ADDRESS SECTION / DETAIL

3D

Parking Garage Sign

PARKING GARAGE SIGN GENERAL REQUIREMENTS

4A

PARKING GARAGE SIGN REQUIRED SPECIFICATIONS

4B

PARKING GARAGE SIGN ELEVATION & PLACEMENT

4C

PARKING GARAGE SIGN SECTION / DETAIL

4D

Elevations

NORTH ELEVATION TYPICAL SIGN PLACEMENT

5A

WEST ELEVATION TYPICAL SIGN PLACEMENT

5B

Colored Simulations

NORTH ELEVATION COLORED SIMULATION

6A

WEST ELEVATION COLORED SIMULATION

6B

Exhibits

PROJECT SITE PLAN

7A

SIGN AREA CALCULATIONS

7B

Property Owner

STERLING REAL ESTATE GROUP, LLC

9735 WILSHIRE BLVD., SUITE 416

BEVERLY HILLS, CA 90212

PHONE: 310.550.1001

FAX: 310.550.7082

Architect

STRUERE ADVANCED ARCHITECTURE

3324 GRAND VIEW

LOS ANGELES, CA 90066

PHONE: 310.748.7649

EMAIL: HRAZTAN@STRUERE.COM

City of Santa Monica

1685 MAIN STREET, SUITE 212

SANTA MONICA, CA 90401

PHONE: 310.548.8341

EMAIL: PLANNING@SMGOV.NET

Sign Consultant

LANDMARK SIGNS, INC.

EMAIL: SALES@LANDMARKSIGNSINC.COM

WEBSITE: WWW.LANDMARKSIGNSINC.COM

PHONE: 714.637.9900

TENANT PROCEDURES & REQUIREMENTS

1. Prior to commencement of any sign work or obtaining permits, Tenant shall submit to the Property Owner 3 copies of detailed shop drawings (11" x 17" format only) prepared by the Tenant's licensed sign contractor to include the following:

A. An accurately scaled full-color elevation of the Tenant's entire storefront depicting the location of the sign and dimensions indicating the Tenant's leasehold frontage, the overall height of the sign and both the vertical and horizontal distances of the sign from the edges of the sign area or appropriate architectural features.

B. An accurately scaled full-color drawing of the sign with fully dimensioned features, letters and logos, and complete specifications of all materials, colors, finishes, means of illumination and other pertinent details.

C. An accurately scaled cross section for each individual sign type depicting the means of attachment or ground placement, all materials and electrical parts to be used, electrical specifications, and dimensions or specifications indicating sign and material height and depth.

D. A sample board may be required with material samples and colors including but not limited to: metals, paint colors and finishes, trims, faces and face decorations and lighting colors.

E. A sample board may be required with material samples and colors including but not limited to: metals, paint colors and finishes, trims, faces and face decorations and lighting colors.

2. If such designs are rejected by the Property Owner, Tenant must resubmit corrected designs until Property Owner's approval is obtained.

3. Tenant's contractors and their agents must be lawfully licensed and bonded according to the State Contractors License Law and possess a minimum of 2 million dollars general liability insurance. The Property Owner may require the Insurance Certification from the contractor or any of its agents providing work of services upon the property, prior to sign approval.

4. Tenant shall not install any sign without all required permits from any local authority holding

jurisdiction over such work. Tenant shall obtain Property Owner's approval prior to making applications for any permits.

5. In the event of any future modifications, revisions or changes to Tenant's signs occurring during the term of the Tenant's lease, Tenant shall resubmit for Property Owner's approval according to the requirements of the original sign submittal process and abide by all of the regulations of this Sign Program.

6. Tenant must not allow building structural or architectural modifications to occur without prior written approval of the Property Owner. Property Owner may require detailed and engineered drawings prior to approval and notwithstanding, all such work must comply with all applicable building and electrical codes.

7. Tenant shall be responsible for all costs associated with the manufacture, installation, maintenance and removal of their signs, including but not limited to, permits, engineering, designs, corrections, building modifications necessary for electrical or service access, repairs, cleaning, refinishing, refurbishing, personal or property damage as a result of sign malfunctions, sign removal and disposal resulting from violation of the regulations of this Sign Program, sign removal and repair of building damage after vacancy or loss of lease.

8. Tenant shall be responsible to see that all of the requirements of this Sign Program are met in regards to Tenant's own signs.

9. Within 30 days of vacating premises or loss of lease, Tenant shall completely remove and dispose of all of Tenant's signs and restore the building surfaces to their original condition.

10. Tenant will be responsible for all costs associated with the removal, disposal and repair of building damages at the Property Owner's discretion if any part of these requirements are violated.

MINIMUM STANDARDS

All signs shall be manufactured and installed according to the following minimum standards:

A. Signs shall be in compliance with U. L. Laboratories, the National Electric Code (NEC), the Uniform Building Code (ICBO) and any other Federal, State and Local building codes that are required.

B. Signs shall bear U. L. labels applied by an U. L.

Laboratories licensed manufacturer, Manufacturer's labels and Permit Stickers (where required). Manufacturer's labels shall not be visible from parking or the street, or from any normal viewing angle. Permit Stickers shall be applied with minimum visibility so as to only comply with the local authority's minimum placement requirements.

C. All sign companies and their agents shall be lawfully licensed and bonded according to the State Contractor's Board requirements and with any local authorities where licensing is required. All sign companies and their agents shall be insured with a minimum of 2 million dollars general liability insurance.

D. No sign shall be installed without Permits from every appropriate local authority and without required preliminary or final inspections, such inspections having been completed within 90 days of the commencement of the sign installation.

E. All signs shall be manufactured and installed according to the highest sign industry standards, using the best quality materials and utilizing the best processes available at the time the work occurs. The Property Owner shall reserve the right to reject any work that it considers sub-standard.

F. Where metal is used in fabricating, such metal shall be preferably aluminum, and any hardware used to fasten signs to the building must be stainless steel or zinc coated to prevent rust. Steel fasteners and parts, framework, etc. must be insulated from aluminum, avoiding direct contact in order to eliminate electrolysis.

G. Signs must be fabricated with little or no visibility of seams, welds or fasteners. All exposed seams must be filled flush and finished so as to be an invisible part of their adjacent surfaces. All exposed welds must be ground smooth and finished so as to be an invisible part of their adjacent surfaces. All exposed fasteners such as rivets and screws must be flush, filled and finished so as to be an invisible part of their adjacent surfaces.

H. Signs must use a minimum .080" depth of material on any flat, exposed surfaces, and any greater depth as required to eliminate "oil canning", any noticeable warping or visibility of any interior frame attachments.

I. No exposed angle clips or black iron may be used as installation hardware. Installation parts must be hidden when possible, and when exposed (such as spacers) to any angle of view, must be painted to match the adjacent building surface.

J. Painted finishes must be smooth and uniformly

covered, without intermittent orange peel, drips or runs and remain free from blistering, peeling, chipping or fading for a minimum of 1-year from the commencement of installation. Enamel paints must be of automotive quality and all painted finishes must be applied using the paint manufacturer's recommended methods, preconditioning and primers.

K. No color hues and finishes prone to early fading may be used. All exposed metals, plastics, vinyls, including printed vinyls and other parts must be painted, finished, applied and / or fabricated in accordance with the original product manufacturer's recommendations in order to maintain a warranty that must be a minimum of 5-years.

PROHIBITED SIGNS

Any sign of the following type or specifications shall be prohibited:

1. Signs advertising any entity, products, events or subjects unrelated to the property upon which said sign is located. This includes but is not limited to Outdoor Advertising, Billboards and Off-Site signs of all types.

2. Signs that constitute a traffic hazard by using symbols, colors, designs or words commonly used on traffic signs and signals in such a manner as to interfere with, mislead or confuse pedestrian or automotive traffic.

3. Signs that flash, make audible sounds, or have animation; or have parts that do so.

4. Signs affixed to vehicles (aside from those used exclusively for delivery) for the purpose of advertising any entity, product, event or subject whether related or unrelated to the property upon which such vehicle is parked. Such vehicles may be towed away at the vehicle owner's expense at the Property Owner's discretion.

5. Temporary signs such as but not limited to banners, flags, pennants or balloons unless specifically allowed by and in accordance with the code of the local authority. Notwithstanding, such signs shall only be permitted with previous written approval by the Property Owner only and are limited to one temporary display per tenant to be displayed for a maximum of 45 day per calendar year.

6. Signs that violate any law or regulation whether Federal, State or Local.

7. Signs in unlawful proximity to power lines and that are attached to or interfere with any public utility.

8. Portable signs, Sandwich Board signs or inflatable displays.

9. Holiday lighting, light bulb strings or the like with the exception of any such decoration that the Property Owner may choose to apply.

10. Signs displaying profanity, obscene images or immoral content as deemed so by the Property Owner.

11. Signs affixed to any parts of the buildings or premises that are not a normally acceptable location for signs such as but not limited to, stand pipes and drains, roofing or roof equipment, roof or parapet flashing, window frames, awnings and canopies, light standards, poles or sign posts.

12. Signs left abandoned beyond 30 days after tenant's lease expires or tenant vacates property whether or not voluntarily.

13. Signs in unclean condition or in need of repair or maintenance for a period not to exceed 30 days.

14. Window signs including but not limited to neon displays, neon window borders, lighted cabinets, non-illuminated vinyl, printed or painted graphics or lettering, except those as specifically permitted in this Sign Program or as permitted by previous written approval of the Property Owner.

15. Paper, cardboard or foam core signs, decals or stickers, graffiti, or any sign that defaces property. Perpetrators of such signs may be liable to arrest and prosecution.

16. Any sign not previously approved by the Property Owner or in violation of this Sign Program. Any sign in violation of these prohibitions may be removed or repaired at the Property Owner's discretion at the violating lessee's expense.

Tenant Sign General Requirements

Permitted Sign Type: INDIVIDUAL LETTER BLOCK ACRYLIC HALO ILLUMINATED LETTERS AS INDICATED ON PAGES 2B, 2D & 2E. (SIGNS MAY ALSO BE NON-ILLUMINATED WITH SAME CONSTRUCTION BUT WITHOUT LED'S.)

Quantity Allowed: ONE SIGN PER TENANT EACH STREET FRONTAGE.

Maximum Logo Height: 24" EXCLUDING FCO BACKGROUND.

Maximum Letter Height: 18" EXCLUDING FCO BACKGROUND.

Maximum Length: 70% OF THE TENANT LEASEHOLD FRONTAGE.

Allowable Area: .8 SQUARE FEET PER LINEAR FOOT OF LEASEHOLD FRONTAGE AS DETERMINED BY TWO PAIRS OF PARALLEL LINES PERIMETER ENCLOSING ALL SIGN ELEMENTS.

Location: LETTER AND LOGO FCO BACKGROUND BASELINES ARE TO BE ALIGNED TO THE TOP OF THE CANOPY (SEE PAGE 2C).

Permitted Design: TENANTS POSSESSING NATIONALLY RECOGNIZED AND TRADEMARKED LOGOS, FONTS AND COLORS ARE PERMITTED TO USE THEM. TENANTS WITHOUT SUCH MAY USE A LOGO DESIGN OF THEIR OWN CREATION BUT MUST USE THE TREBUCHET MS FONTS SHOWN ON PAGE 2E, IN OPAQUE BLACK FINISH.



This is an original, heretofore unpublished drawing created by Landmark Signs, Inc., in conjunction with a project in planning for a specific client. As such, it is protected by Copyright Law from the date of origin on this page. It is not to be copied, reproduced, or exhibited by any method or through any medium to anyone outside of the client's organization in whole or in part without the express written authorization of Landmark Signs, Inc. Violators of these requirements may be prosecuted by Landmark Signs, Inc. and held liable for any damages that result from those actions.

Project	900 Wilshire Sign Program	R1
Address	900 Wilshire Blvd.	R2
City, State, Zip	Santa Monica, CA	R3
Design	17.016	R4
Date	04.30.2017	R5
Scale	Noted	R6
Page	4 of 24	R7

www.landmarksignsinc.com
 2456 N. Glassell St., Suite A
 Orange, CA 92865
 Cont. Lic. No. 507915
 Fax: 714.637.9902
714.637.9900

Tenant Sign Required Specifications

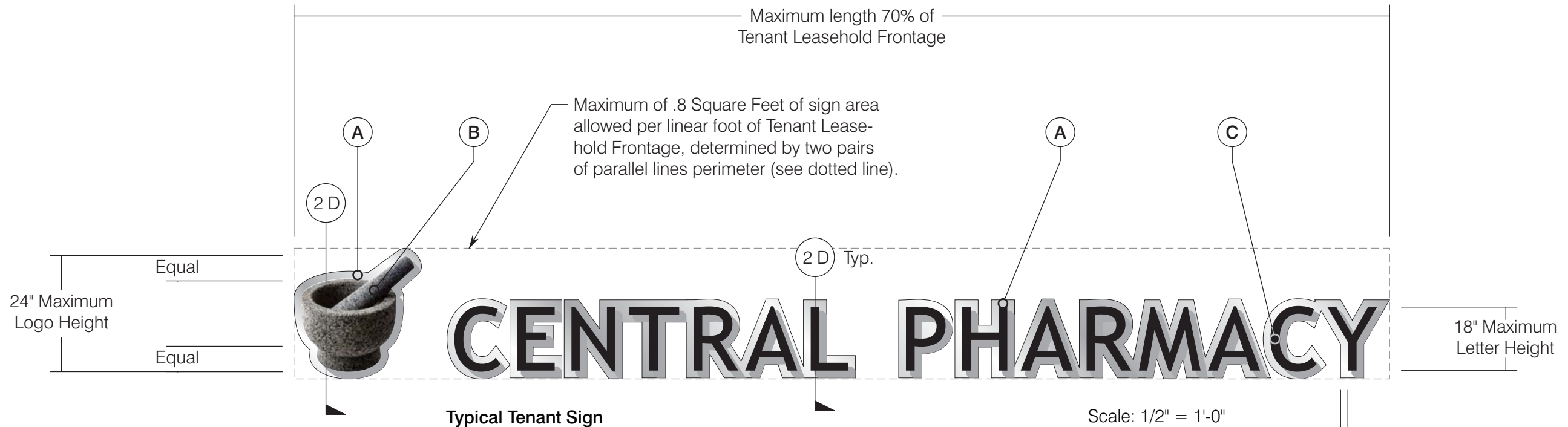

Typical Tenant Sign

Required Materials & Finishes

- A. 1/2" thick water jet cut FCO dimensional anodized brushed aluminum logo / letter backs.
- B. 30mm Letter Block Acrylic with inserted white LED's, 3M (or equivalent) translucent applied vinyl with a 5 year minimum warranted digital print (if printed) on the face and edges painted with opaque Matthews Acrylic Polyurethane to match the adjacent logo face color.
- C. 30mm Letter Block Acrylic with inserted white LED's, .125 aluminum with a Black satin Matthews acrylic polyurethane finish laminated over the face and edges painted with Black satin opaque Matthews acrylic polyurethane.

Note: Rear structure, raceways & background rear surfaces to be painted with Matthews Acrylic Polyurethane enamel to match adjacent building surfaces (see Page 2 F).

Tenant Sign Typical Placement

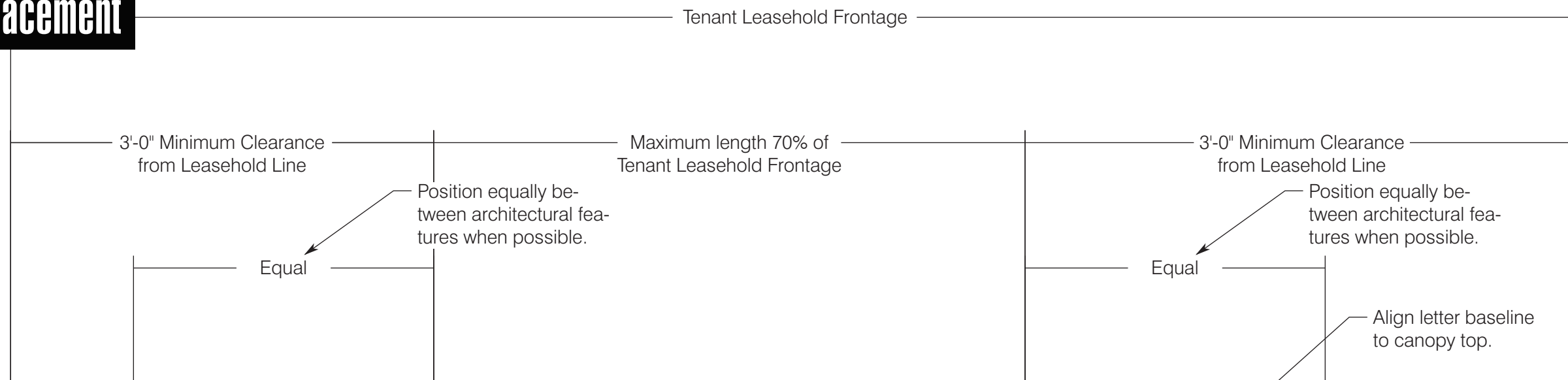

Typical Tenant Elevation

Scale: 1/4" = 1'-0"



**LANDMARK
SIGNS
INC.**
We're Here For You.

This is an original, heretofore unpublished drawing created by Landmark Signs, Inc., in conjunction with a project in planning for a specific client. As such, it is protected by Copyright Law from the date of origin on this page. It is not to be copied, reproduced, or exhibited by any method or through any medium to anyone outside of the client's organization in whole or in part without the express written authorization of Landmark Signs, Inc. Violators of these requirements may be prosecuted by Landmark Signs, Inc. and held liable for any damages that result from those actions.

Project	900 Wilshire Sign Program	R1
Address	900 Wilshire Blvd.	R2
City, State, Zip	Santa Monica, CA	R3
Design	17.016	R4
Date	04.30.2017	R5
Scale	Noted	R6
Page	7 of 24	R7

www.landmarksignsinc.com
2456 N. Glassell St., Suite A
Orange, CA 92865
Cont. Lic. No. 507915
Fax: 714.637.9902
714.637.9900

Tenant Sign Typical Section

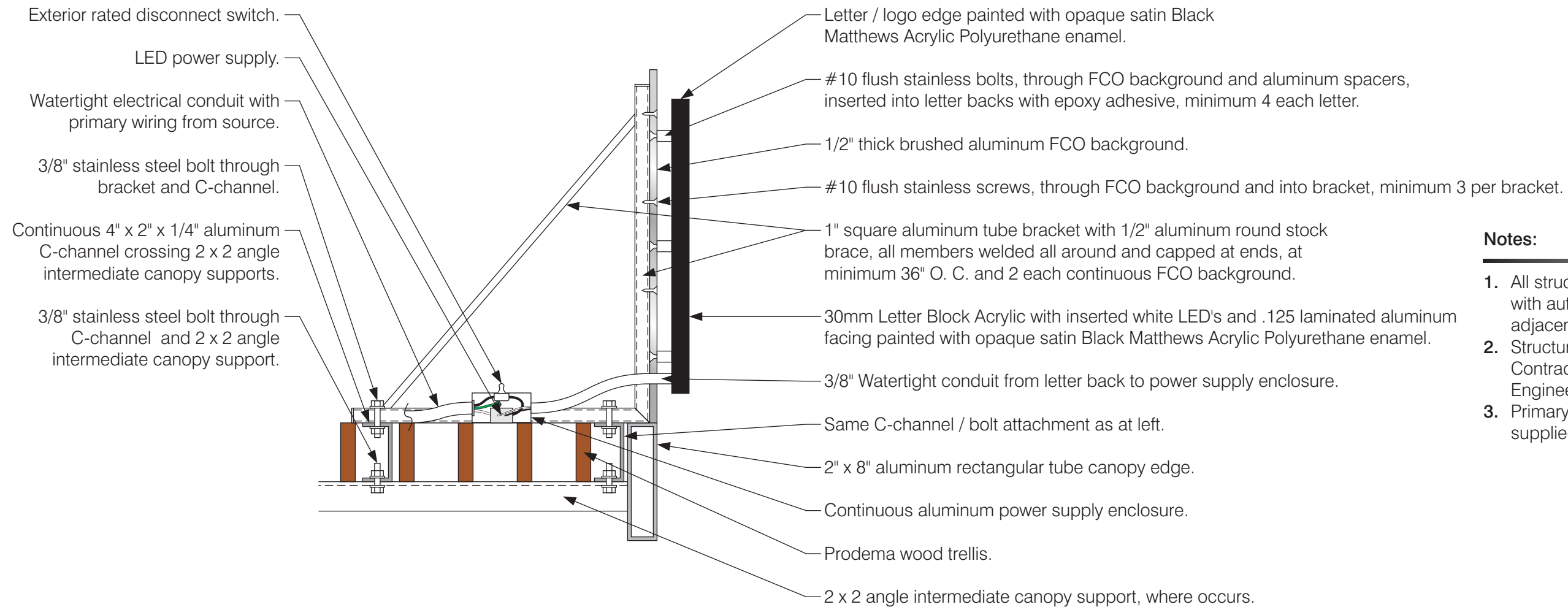

Notes:

1. All structural members to be primed and painted with automotive quality finishes to match the adjacent building surface.
2. Structural components are subject to Sign Contractor supplied Licensed Structural Engineering.
3. Primary electrical wiring from source is to be supplied by tenant and / or property owner.

Typical Tenant Sign Section

Scale: 1 1/2" = 1'-0"



**LANDMARK
SIGNS
INC.**
We're Here For You.

This is an original, heretofore unpublished drawing created by Landmark Signs, Inc., in conjunction with a project in planning for a specific client. As such, it is protected by Copyright Law from the date of origin on this page. It is not to be copied, reproduced, or exhibited by any method or through any medium to anyone outside of the client's organization in whole or in part without the express written authorization of Landmark Signs, Inc. Violators of these requirements may be prosecuted by Landmark Signs, Inc. and held liable for any damages that result from those actions.

Project	900 Wilshire Sign Program	R1
Address	900 Wilshire Blvd.	R2
City, State, Zip	Santa Monica, CA	R3
Design	17.016	R4
Date	04.30.2017	R5
Scale	Noted	R6
Page	9 of 24	R7

www.landmarksignsinc.com
2456 N. Glassell St., Suite A
Orange, CA 92865
Cont. Lic. No. 507915
Fax: 714.637.9902
714.637.9900

2D

**Tenant Sign Required
Fonts & Lighting**

TREBUCHET MS NORMAL

ABDEFGHIJKLMNOPQRSTUVWXYZ
 abcdefghijklmnopqrstuvwxyz
 !\$%&()? ‘ ’ / “ ” 1234567890

TREBUCHET MS BOLD

ABDEFGHIJKLMNOPQRSTUVWXYZ
 abcdefghijklmnopqrstuvwxyz
 !\$%&()? ‘ ’ / “ ” 1234567890

Logo graphics illumin-
ate from within.

Letter faces and
edges are opaque

Letters and logo halo illuminate
onto FCO backgrounds.



Typical Tenant Sign - Simulated Night View

Scale: 3/8" = 1'-0"



**LANDMARK
SIGNS
INC.**
We're Here For You.

This is an original, heretofore unpublished drawing created by Landmark Signs, Inc., in conjunction with a project in planning for a specific client. As such, it is protected by Copyright Law from the date of origin on this page. It is not to be copied, reproduced, or exhibited by any method or through any medium to anyone outside of the client's organization in whole or in part without the express written authorization of Landmark Signs, Inc. Violators of these requirements may be prosecuted by Landmark Signs, Inc. and held liable for any damages that result from those actions.

Project	900 Wilshire Sign Program	R1
Address	900 Wilshire Blvd.	R2
City, State, Zip	Santa Monica, CA	R3
Design	17.016	R4
Date	04.30.2017	R5
Scale	Noted	R6
Page	11 of 24	R7

www.landmarksignsinc.com
 2456 N. Glassell St., Suite A
 Orange, CA 92865
 Cont. Lic. No. 507915
 Fax: 714.637.9902
714.637.9900

Building Address General Requirements

Permitted Sign Type: INDIVIDUAL DIMENSIONAL FCO ANODIZED BRUSHED ALUMINUM NUMERALS (SEE PAGE 3B)

Quantity Allowed: ONE

Maximum Height: 24"

Maximum Length: 6' - 3 3/16"

Allowable Area: 12.54 SQUARE FEET.

Location: CENTERED OVER BUILDING MAIN ENTRANCE, BOTTOM FLUSH TO THE TOP OF THE UPPER FLOOR PROJECTION.



**LANDMARK
SIGNS
INC.**
We're Here For You.

This is an original, heretofore unpublished drawing created by Landmark Signs, Inc., in conjunction with a project in planning for a specific client. As such, it is protected by Copyright Law from the date of origin on this page. It is not to be copied, reproduced, or exhibited by any method or through any medium to anyone outside of the client's organization in whole or in part without the express written authorization of Landmark Signs, Inc. Violators of these requirements may be prosecuted by Landmark Signs, Inc. and held liable for any damages that result from those actions.

Project	900 Wilshire Sign Program	R1
Address	900 Wilshire Blvd.	R2
City, State, Zip	Santa Monica, CA	R3
Design	17.016	R4
Date	04.30.2017	R5
Scale	Noted	R6
Page	12 of 24	R7

www.landmarksignsinc.com
2456 N. Glassell St., Suite A
Orange, CA 92865
Cont. Lic. No. 507915
Fax: 714.637.9902
714.637.9900

3A

Building Address Required Specifications

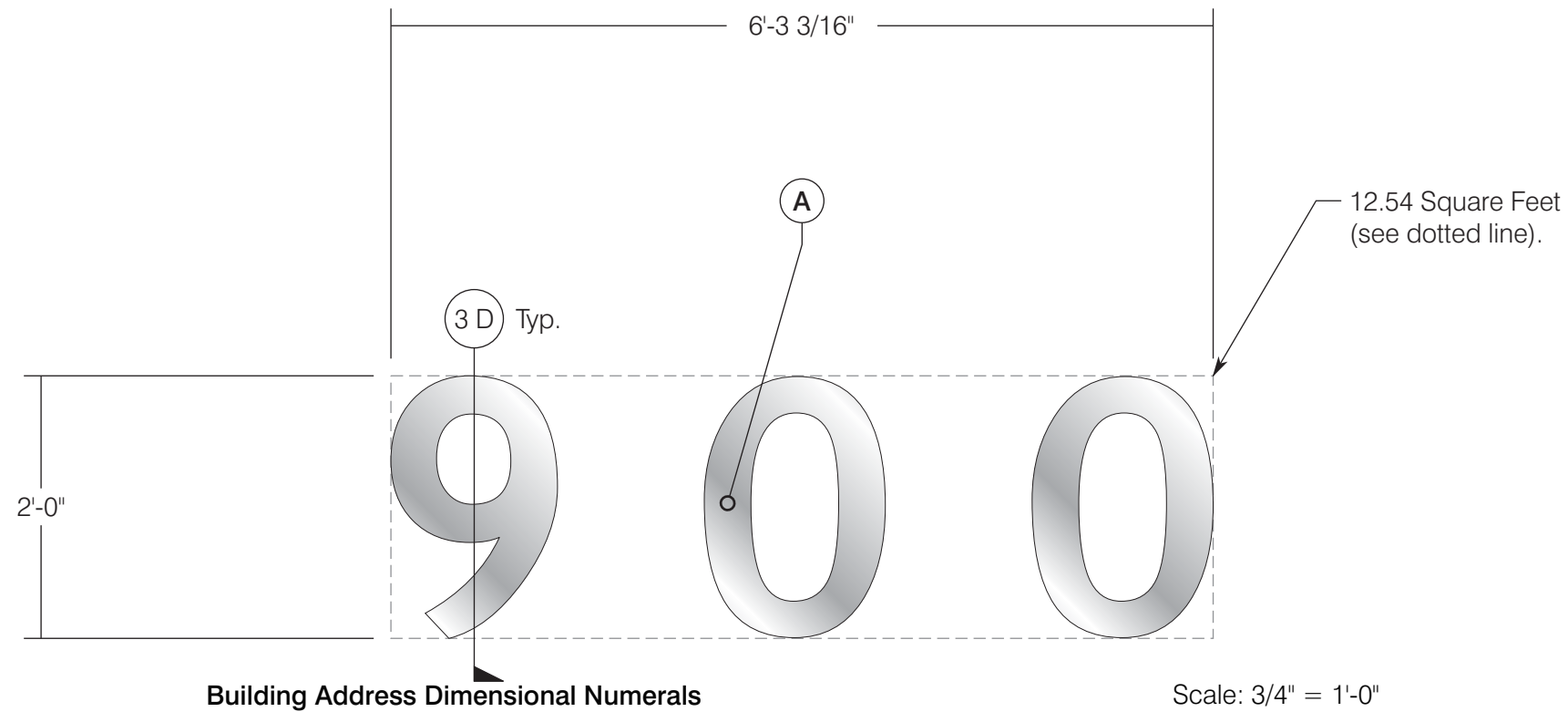

Required Material & Finish

- A. 1" thick water jet cut FCO dimensional anodized brushed aluminum, installed top flush to the bottom of the upper floor projection.

Building Address Elevation & Placement

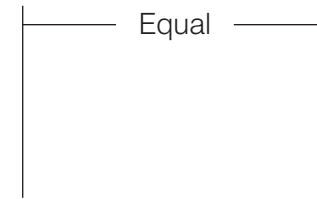
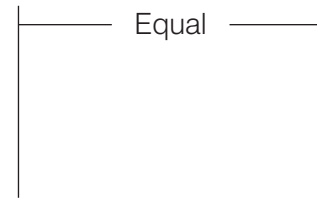

Install bottom flush to the top of the upper floor projection.



Main Entrance Elevation

Scale: 1/4" = 1'-0"



**LANDMARK
SIGNS
INC.**

We're Here For You.

This is an original, heretofore unpublished drawing created by Landmark Signs, Inc., in conjunction with a project in planning for a specific client. As such, it is protected by Copyright Law from the date of origin on this page. It is not to be copied, reproduced, or exhibited by any method or through any medium to anyone outside of the client's organization in whole or in part without the express written authorization of Landmark Signs, Inc. Violators of these requirements may be prosecuted by Landmark Signs, Inc. and held liable for any damages that result from those actions.

Project	900 Wilshire Sign Program	R1
Address	900 Wilshire Blvd.	R2
City, State, Zip	Santa Monica, CA	R3
Design	17.016	R4
Date	04.30.2017	R5
Scale	Noted	R6
Page	14 of 24	R7

www.landmarksignsinc.com
 2456 N. Glassell St., Suite A
 Orange, CA 92865
 Cont. Lic. No. 507915
 Fax: 714.637.9902
714.637.9900



Building Address Section / Detail

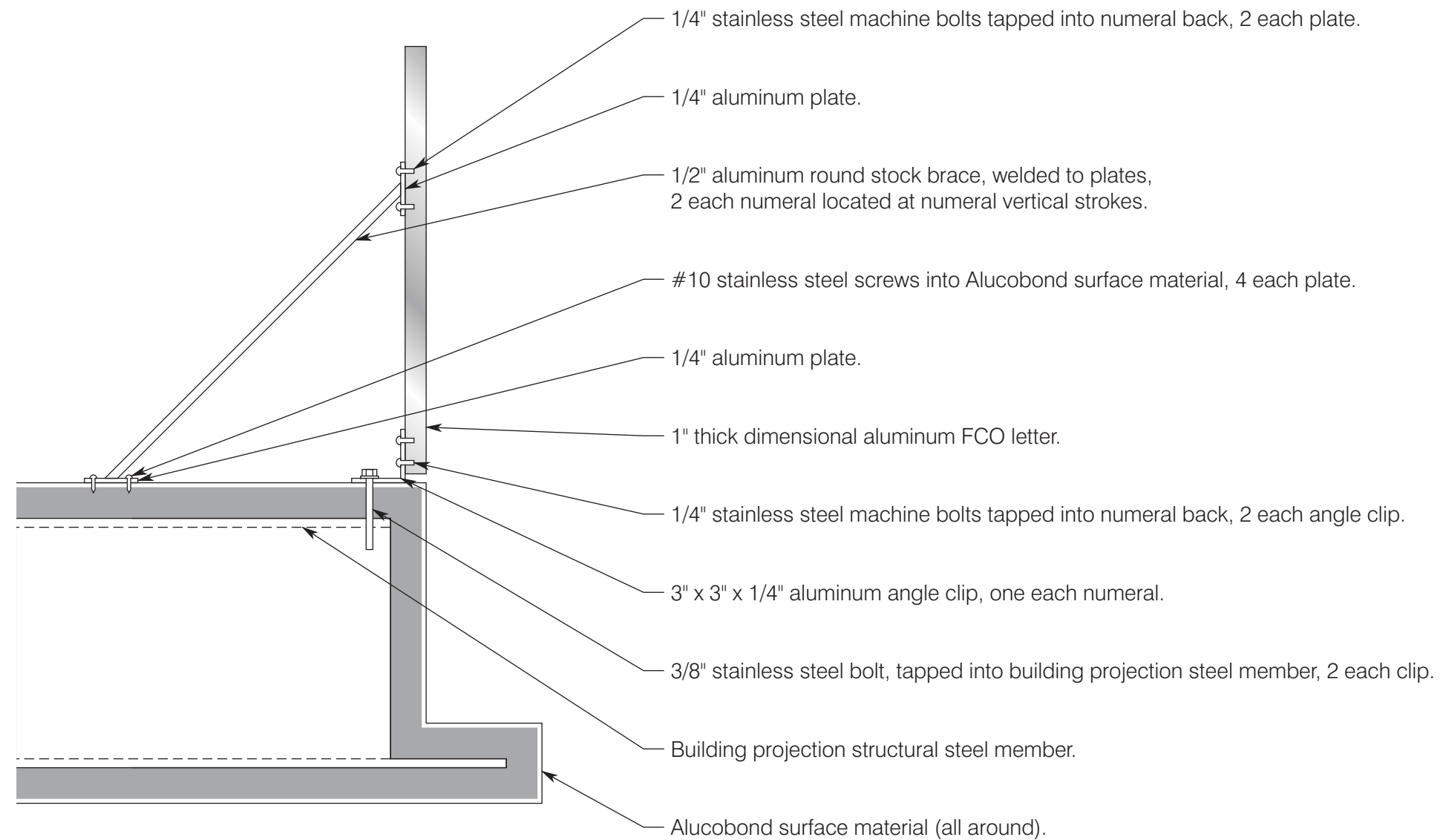

Building Address Section / Detail

Scale: 1 1/2" = 1'-0"

Notes:

1. All structural members to be primed and painted with automotive quality finishes to match the adjacent building surface.
2. Structural components are subject to Sign Contractor supplied Licensed Structural Engineering.



**LANDMARK
SIGNS
INC.**

We're Here For You.

This is an original, heretofore unpublished drawing created by Landmark Signs, Inc., in conjunction with a project in planning for a specific client. As such, it is protected by Copyright Law from the date of origin on this page. It is not to be copied, reproduced, or exhibited by any method or through any medium to anyone outside of the client's organization in whole or in part without the express written authorization of Landmark Signs, Inc. Violators of these requirements may be prosecuted by Landmark Signs, Inc. and held liable for any damages that result from those actions.

Project	900 Wilshire Sign Program	R1
Address	900 Wilshire Blvd.	R2
City, State, Zip	Santa Monica, CA	R3
Design	17.016	R4
Date	04.30.2017	R5
Scale	Noted	R6
Page	15 of 24	R7

www.landmarksignsinc.com
 2456 N. Glassell St., Suite A
 Orange, CA 92865
 Cont. Lic. No. 507915
 Fax: 714.637.9902
714.637.9900

3D

Parking Garage Sign General Requirements

Permitted Sign Type: INDIVIDUAL DIMENSIONAL FCO ALUMINUM LETTERS, FINISHED WITH BLACK SATIN MATTHEWS ACRYLIC POLYURETHANE ENAMEL (SEE PAGE 4B)

Quantity Allowed: ONE

Maximum Height: 18"

Maximum Length: 9' - 10"

Allowable Area: 14.75 SQUARE FEET.

Location: CENTERED UPON FASCIA OVER PARKING GARAGE ENTRANCE.



**LANDMARK
SIGNS
INC.**
We're Here For You.

This is an original, heretofore unpublished drawing created by Landmark Signs, Inc., in conjunction with a project in planning for a specific client. As such, it is protected by Copyright Law from the date of origin on this page. It is not to be copied, reproduced, or exhibited by any method or through any medium to anyone outside of the client's organization in whole or in part without the express written authorization of Landmark Signs, Inc. Violators of these requirements may be prosecuted by Landmark Signs, Inc. and held liable for any damages that result from those actions.

Project	900 Wilshire Sign Program	R1
Address	900 Wilshire Blvd.	R2
City, State, Zip	Santa Monica, CA	R3
Design	17.016	R4
Date	04.30.2017	R5
Scale	Noted	R6
Page	16 of 24	R7

www.landmarksignsinc.com
2456 N. Glassell St., Suite A
Orange, CA 92865
Cont. Lic. No. 507915
Fax: 714.637.9902
714.637.9900

4A

Parking Garage Sign Required Specifications

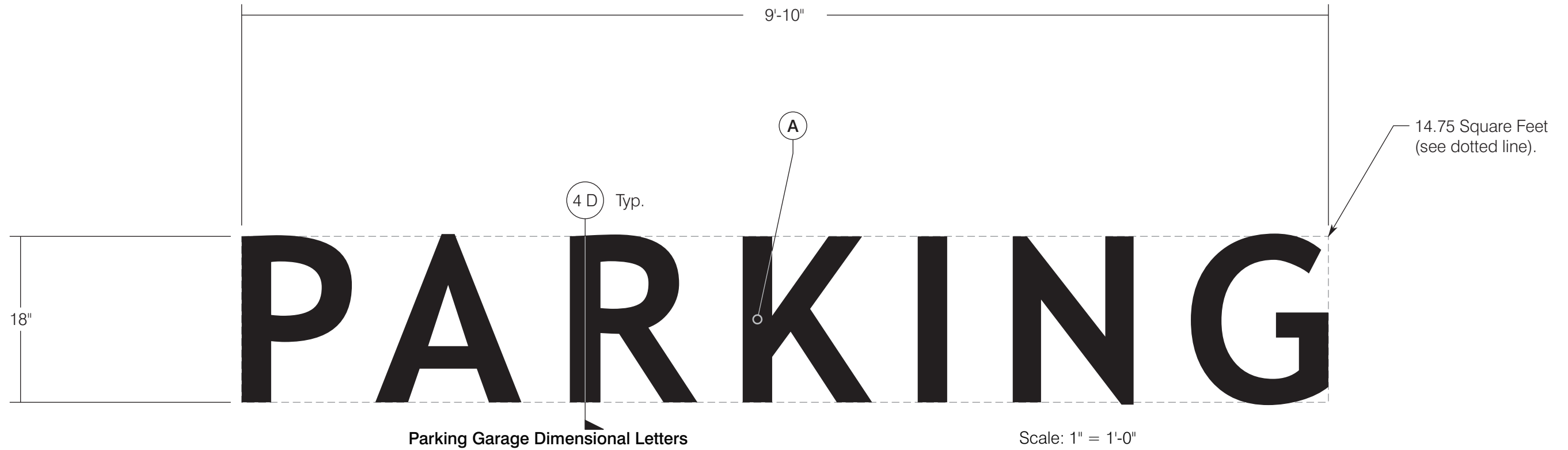

Required Material & Finish

- A. 1" thick water jet cut FCO dimensional aluminum with a Black satin Matthews acrylic polyurethane enamel finish, installed 1" from wall surface.

Parking Garage Sign Elevation & Placement

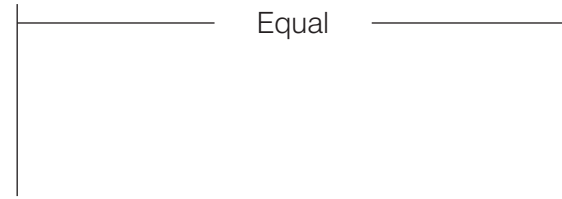
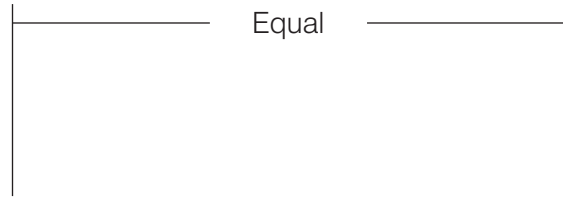

Parking Garage Elevation

Scale: 1/4" = 1'-0"



**LANDMARK
SIGNS
INC.**

We're Here For You.

This is an original, heretofore unpublished drawing created by Landmark Signs, Inc., in conjunction with a project in planning for a specific client. As such, it is protected by Copyright Law from the date of origin on this page. It is not to be copied, reproduced, or exhibited by any method or through any medium to anyone outside of the client's organization in whole or in part without the express written authorization of Landmark Signs, Inc. Violators of these requirements may be prosecuted by Landmark Signs, Inc. and held liable for any damages that result from those actions.

Project	900 Wilshire Sign Program	R1
Address	900 Wilshire Blvd.	R2
City, State, Zip	Santa Monica, CA	R3
Design	17.016	R4
Date	04.30.2017	R5
Scale	Noted	R6
Page	18 of 24	R7

www.landmarksignsinc.com
 2456 N. Glassell St., Suite A
 Orange, CA 92865
 Cont. Lic. No. 507915
 Fax: 714.637.9902
714.637.9900

4C

Parking Garage Sign Section / Detail

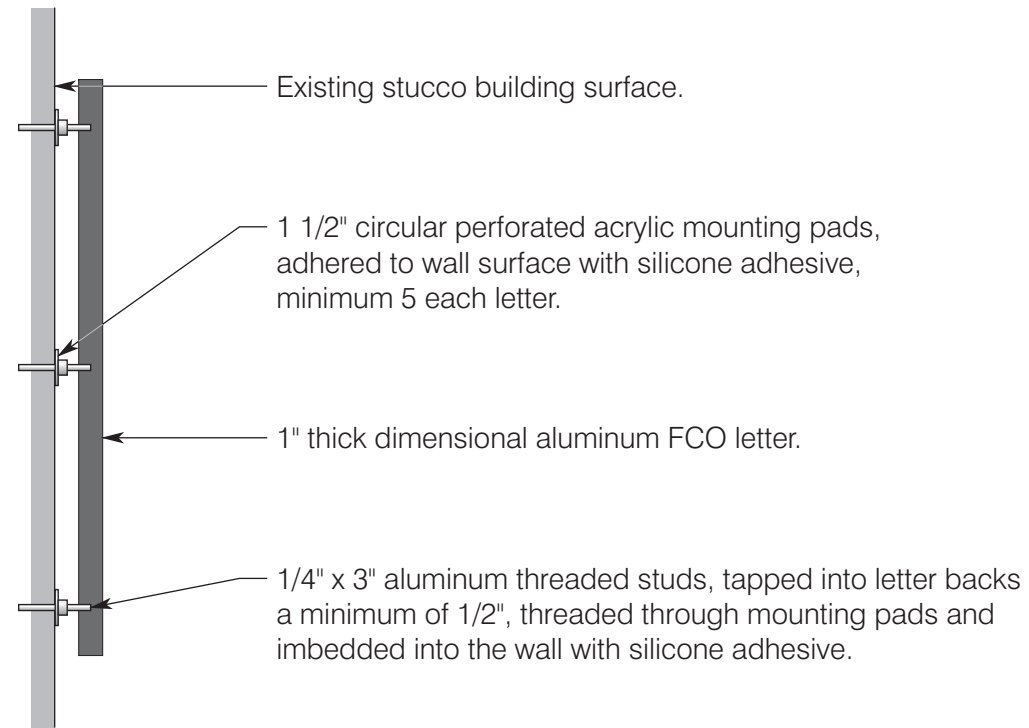

Parking Garage Sign Section / Detail

Scale: 1 1/2" = 1'-0"



**LANDMARK
SIGNS
INC.**
We're Here For You.

This is an original, heretofore unpublished drawing created by Landmark Signs, Inc., in conjunction with a project in planning for a specific client. As such, it is protected by Copyright Law from the date of origin on this page. It is not to be copied, reproduced, or exhibited by any method or through any medium to anyone outside of the client's organization in whole or in part without the express written authorization of Landmark Signs, Inc. Violators of these requirements may be prosecuted by Landmark Signs, Inc. and held liable for any damages that result from those actions.

Project	900 Wilshire Sign Program	R1
Address	900 Wilshire Blvd.	R2
City, State, Zip	Santa Monica, CA	R3
Design	17.016	R4
Date	04.30.2017	R5
Scale	Noted	R6
Page	19 of 24	R7

www.landmarksignsinc.com
2456 N. Glassell St., Suite A
Orange, CA 92865
Cont. Lic. No. 507915
Fax: 714.637.9902
714.637.9900

4 D

North Elevation Typical Sign Placement



North Building Elevation Showing Typical Sign Locations

Scale: 3/32" = 1'-0"

West Elevation Typical Sign Placement



West Building Elevation Showing Typical Sign Location

Scale: 3/32" = 1'-0"



**LANDMARK
SIGNS
INC.**

We're Here For You.

This is an original, heretofore unpublished drawing created by Landmark Signs, Inc., in conjunction with a project in planning for a specific client. As such, it is protected by Copyright Law from the date of origin on this page. It is not to be copied, reproduced, or exhibited by any method or through any medium to anyone outside of the client's organization in whole or in part without the express written authorization of Landmark Signs, Inc. Violators of these requirements may be prosecuted by Landmark Signs, Inc. and held liable for any damages that result from those actions.

Project	900 Wilshire Sign Program	R1
Address	900 Wilshire Blvd.	R2
City, State, Zip	Santa Monica, CA	R3
Design	17.016	R4
Date	04.30.2017	R5
Scale	Noted	R6
Page	21 of 24	R7

www.landmarksignsinc.com
 2456 N. Glassell St., Suite A
 Orange, CA 92865
 Cont. Lic. No. 507915
 Fax: 714.637.9902
714.637.9900

5B

North Elevation Colored Simulation



**LANDMARK
SIGNS
INC.**
We're Here For You.

This is an original, heretofore unpublished drawing created by Landmark Signs, Inc., in conjunction with a project in planning for a specific client. As such, it is protected by Copyright Law from the date of origin on this page. It is not to be copied, reproduced, or exhibited by any method or through any medium to anyone outside of the client's organization in whole or in part without the express written authorization of Landmark Signs, Inc. Violators of these requirements may be prosecuted by Landmark Signs, Inc. and held liable for any damages that result from those actions.

Project	900 Wilshire Sign Program	R1
Address	900 Wilshire Blvd.	R2
City, State, Zip	Santa Monica, CA	R3
Design	17.016	R4
Date	04.30.2017	R5
Scale	Noted	R6
Page	22 of 24	R7

www.landmarksignsinc.com
2456 N. Glassell St., Suite A
Orange, CA 92865
Cont. Lic. No. 507915
Fax: 714.637.9902
714.637.9900

6 A

West Elevation Colored Simulation



**LANDMARK
SIGNS
INC.**

We're Here For You.

This is an original, heretofore unpublished drawing created by Landmark Signs, Inc., in conjunction with a project in planning for a specific client. As such, it is protected by Copyright Law from the date of origin on this page. It is not to be copied, reproduced, or exhibited by any method or through any medium to anyone outside of the client's organization in whole or in part without the express written authorization of Landmark Signs, Inc. Violators of these requirements may be prosecuted by Landmark Signs, Inc. and held liable for any damages that result from those actions.

Project	900 Wilshire Sign Program	R1
Address	900 Wilshire Blvd.	R2
City, State, Zip	Santa Monica, CA	R3
Design	17.016	R4
Date	04.30.2017	R5
Scale	Noted	R6
Page	23 of 24	R7

www.landmarksignsinc.com
 2456 N. Glassell St., Suite A
 Orange, CA 92865
 Cont. Lic. No. 507915
 Fax: 714.637.9902
714.637.9900

6 B

Project Site Plan

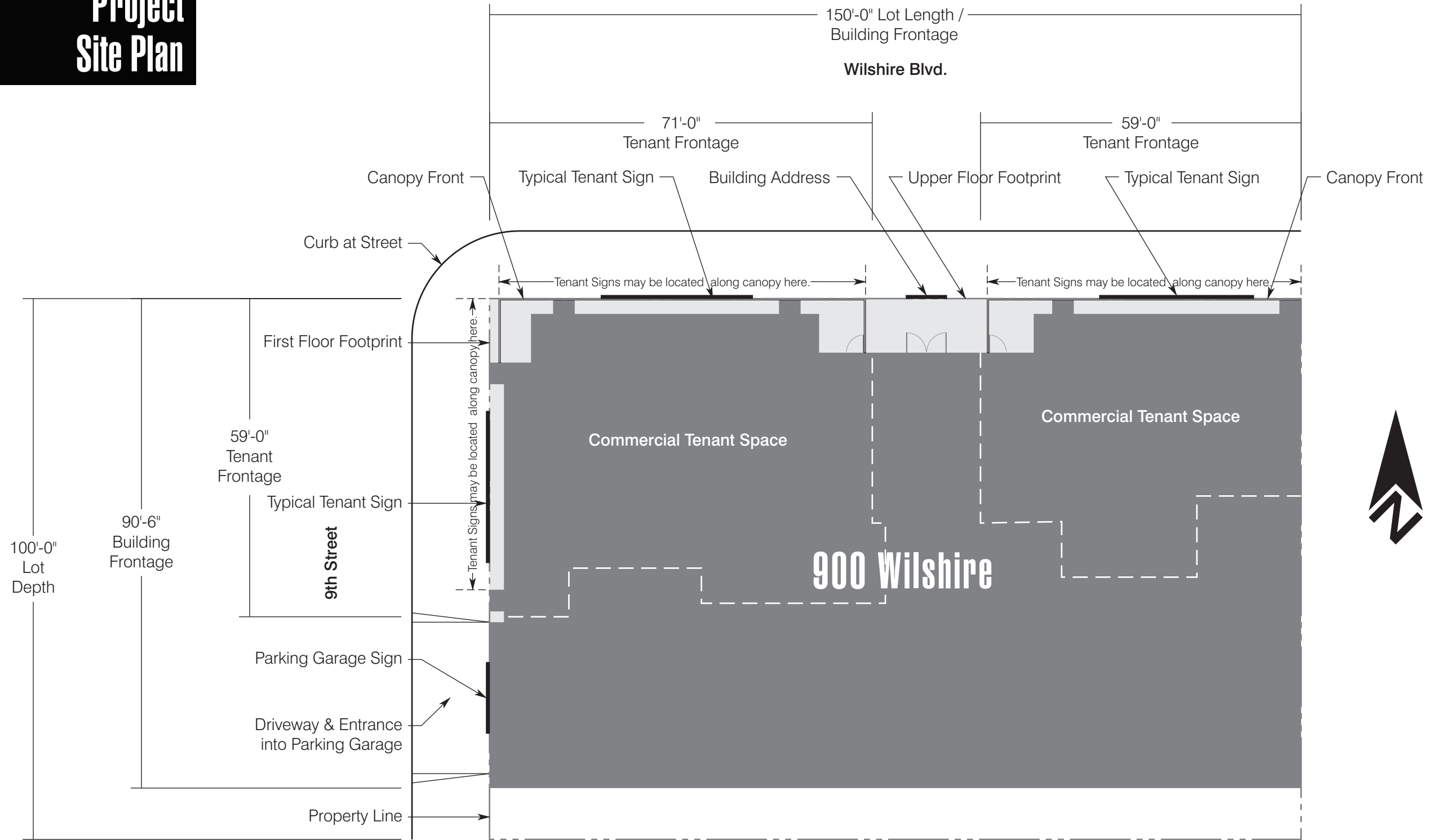

Site Plan

Scale: 1" = 20'-0"



**LANDMARK
SIGNS
INC.**

We're Here For You.

This is an original, heretofore unpublished drawing created by Landmark Signs, Inc., in conjunction with a project in planning for a specific client. As such, it is protected by Copyright Law from the date of origin on this page. It is not to be copied, reproduced, or exhibited by any method or through any medium to anyone outside of the client's organization in whole or in part without the express written authorization of Landmark Signs, Inc. Violators of these requirements may be prosecuted by Landmark Signs, Inc. and held liable for any damages that result from those actions.

Project	900 Wilshire Sign Program	R1
Address	900 Wilshire Blvd.	R2
City, State, Zip	Santa Monica, CA	R3
Design	17.016	R4
Date	04.30.2017	R5
Scale	Noted	R6
Page	24 of 24	R7

www.landmarksignsinc.com
 2456 N. Glassell St., Suite A
 Orange, CA 92865
 Cont. Lic. No. 507915
 Fax: 714.637.9902
714.637.9900

7A

Allowable Sign Area Per Code:

TOTAL BUILDING ADDRESS FRONTAGE (WILSHIRE): **150'-0"**

TOTAL ALLOWABLE BUILDING SIGN AREA PER
CODE (1 1/2 TIMES ADDRESS FRONTAGE): **225 Sq. Ft.**

Sign Area Allowed Per This Sign Program:

TOTAL TENANT LINEAR LEASEHOLD FRONTAGE: **189'-0"**

TOTAL BUILDING TENANT SIGN AREA ALLOWED THIS PROGRAM
(.8 SQUARE FOOT EACH LINEAR FOOT OF LEASEHOLD FRONTAGE): **151.2 Sq. Ft.**

AREA OF PARKING GARAGE SIGN: **14.75 Sq. Ft.**

AREA OF BUILDING ADDRESS: **12.54 Sq. Ft.**

TOTAL SIGN AREA ALLOWED PER THIS SIGN PROGRAM: **178.49 Sq. Ft.**

Remaining Sign Area Usable For Other Sign Uses:

TOTAL SIGN AREA ALLOWED PER CODE: **225 Sq. Ft.**

LESS THE TOTAL SIGN AREA ALLOWED PER THIS SIGN PROGRAM: **178.49 Sq. Ft.**

REMAINING SIGN AREA USABLE PER CODE FOR OTHER SIGN USES: **46.51 Sq. Ft.**

